



REHAU®

Unlimited Polymer Solutions



GERMAN WINDOW PROFILE SYSTEMS

EFFICIENCY. ECONOMY. DESIGN.



www.rehau.ae

Construction
Automotive
Industry

REHAU - GERMAN TECHNOLOGY

WE THINK GLOBAL AND ACT LOCAL

Worldwide Locations:

- 132 sales offices
- ▲ 41 production plants
- ★ 16 administrative offices
- 9 distribution centers

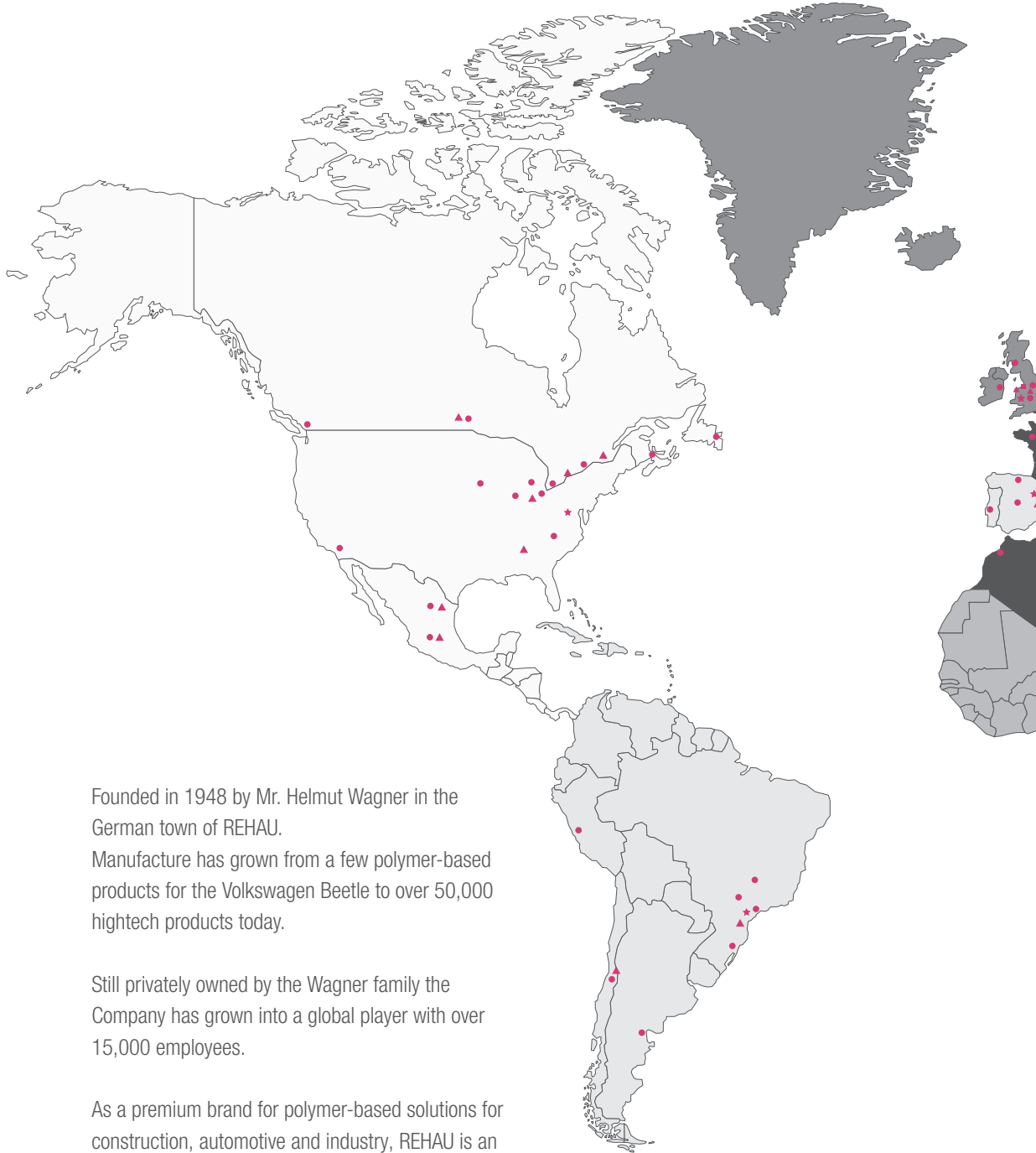

Founded in 1948 by Mr. Helmut Wagner in the German town of REHAU.

Manufacture has grown from a few polymer-based products for the Volkswagen Beetle to over 50,000 hightech products today.

Still privately owned by the Wagner family the Company has grown into a global player with over 15,000 employees.

As a premium brand for polymer-based solutions for construction, automotive and industry, REHAU is an international leader. We generate continuous growth based on our own strengths with regard to innovative skills and competence in surface technology as well as material and systems development.

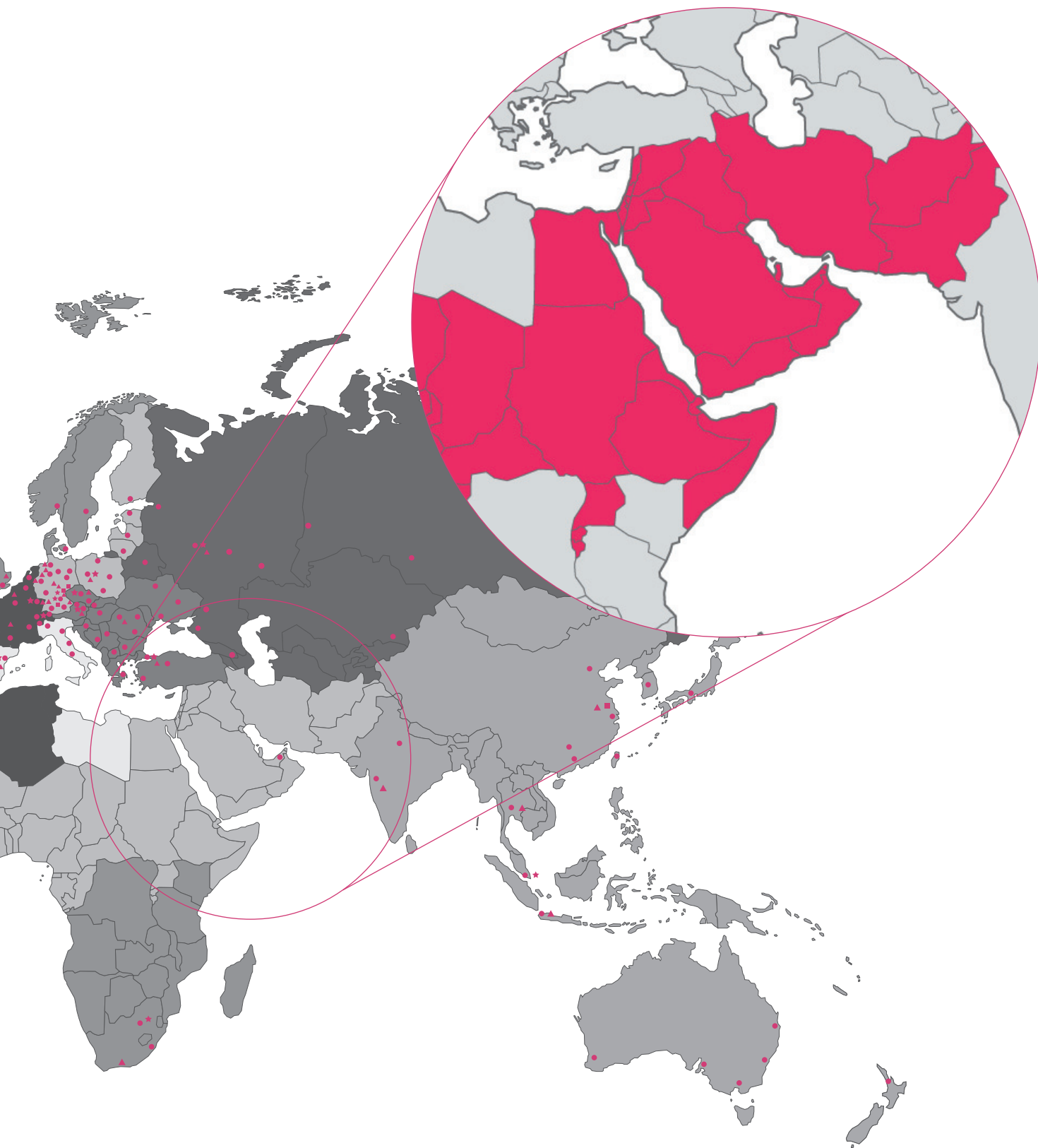

Countries supported by the VAE Sales office:

- United Arab Emirates
- Qatar
- Bahrain
- Oman
- Saudi Arabia
- Kuwait

Sales office Dubai:

Established 2006 in the Jebel Ali Free Zone

Please contact us:

REHAU FZE
P.O. Box 261 731
LIU RA08-TD05

REHAU Warehouse:

Qazvin Bein Ziyaran Va Mirpanji
Km120 Jade Ghadim
Tehran, Iran

REHAU – UNLIMITED POLYMER SOLUTIONS

CONSTRUCTION, AUTOMOTIVE, INDUSTRY

REHAU provides "Unlimited Polymer Solutions," and is the premium worldwide brand for polymer-based innovations and systems in construction, automotive and industry sectors.

Strong development capabilities and synergistic efficiencies based on experience in many industries give the modern company its unique presence in the world of plastics.

The company's core competencies in materials development, systems design and surface technology allow it to drive innovation forward. A passion for the unlimited potential of polymers enables REHAU to regularly identify new products for companies and consumers.



CONSTRUCTION

As a leading supplier of polymer-based solutions to the construction industry, REHAU addresses sustainable design priorities by technical products that enhance comfort and convenience, reduce energy costs, create healthy and safe environments, and conserve finite resources. REHAU's products and systems for the window and door, heating and plumbing, fire protection and pipe markets complement each other in integrated high-performance solutions.

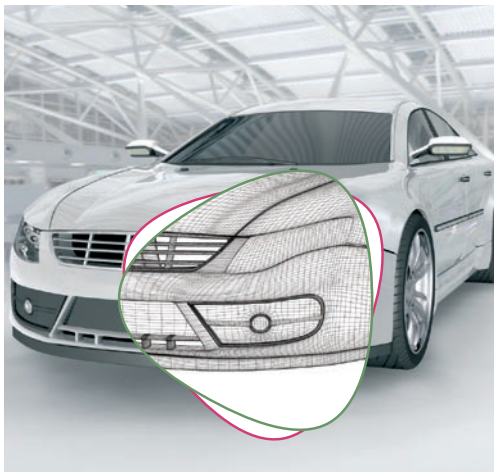

AUTOMOTIVE

REHAU optimizes design, comfort and safety as a creative development partner to the automotive industry. With key programs including exterior components such as bumpers and fenders, intelligent modules for water and air management, and thermoplastic sealing systems, REHAU is a worldwide premium supplier to all major automotive manufacturers.

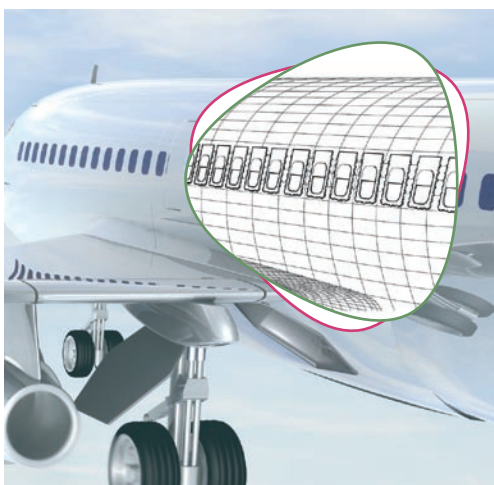

INDUSTRY

With its polymer-based innovations, REHAU is a leading supplier of products and systems to industry. From furniture to appliance to transportation, REHAU solutions offer superior performance and design features that integrate seamlessly into its customers' production environments.

SATISFIED CUSTOMERS

WINDOWS AND DOORS MADE IN GERMANY FROM REHAU PROFILE SYSTEMS.

REHAU offers an extensive range of products for windows and doors providing you with just the right solution for all your requirements, replacement and new construction markets alike. Window solutions matching your requirements are available from qualified window specialists, fabricated with modern machines by trained staff to ensure your success.



Technology for success

Windows and doors made of REHAU profiles meet the highest standards of quality and design to give you peace of mind. Over forty years experience in the manufacturing of RAU-PVC window profiles, certification to DIN ISO 9001, in addition to internal and external quality control, results in quality of a consistently high standard.

Design for success

Whether new construction or replacement – with windows and doors made of REHAU profile systems you can meet all your requirements.

Individually planned design – with windows and doors made of REHAU profile systems

Excellent design and highest quality are the features of REHAU.



This quality-mark assures REHAU quality.

These advantages will convince you:

- **Thermal insulation:** Multi-chamber technology combined with special insulated glass ensures that the temperature remains constant, even in air conditioned and heated rooms – totally independent of the weather conditions – for comfortable living.
- **Security:** The window profiles are optimally designed to use special security locks and strikers as well as intrusion resistant measures.
- **Sealing:** Wide gasket overlap provides optimum protection against dust, wind and rain – thus ensuring that you feel comfortable. Noise protection: Special sound insulated glass keeps external noise outside – thus ensuring a quiet life.
- **Easy to clean:** The smooth surfaces do not attract dirt and can be quickly and easily cleaned – leaving time for the things that matter.
- **Highly durable:** REHAU profiles are made from our high performance formula RAU-PVC 1476 to match even very difficult climatic conditions, such as extreme temperatures of salt-laden sea air.
- **Noise protection:** special sound insulated glass keeps external noise outside – this ensures a quiet life.

Material RAU-PVC 1476

RAU-PVC 1476 is REHAU's own UV and corrosion resistant formula. It is suitable for use even under extreme climatic conditions. Windows made of RAU-PVC 1476 can be installed in regions experiencing up to 190 kcal/cm² radiation level per year. The RAU-PVC 1476 material is extremely weatherproof, protected against solar radiation, low-maintenance and continually contributing to the value of the property of your house.

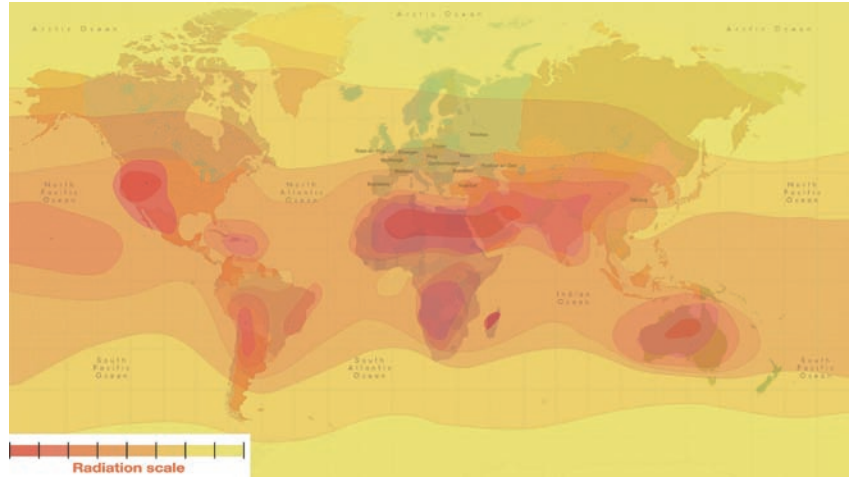

Quality and certification: REHAU Window Systems meet international quality and regulatory standards, and are accredited by both international as well as domestic bodies.

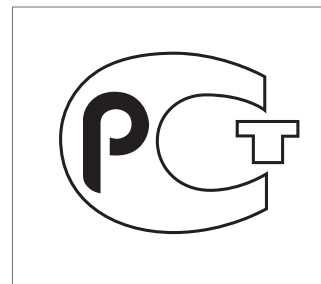
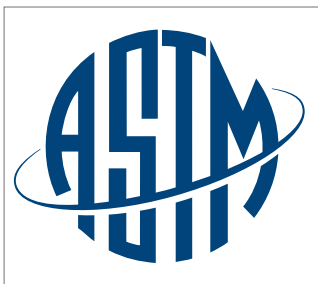

Quality Management System
for Development, Manufacture and
Distribution of Products and Systems
made from Polymer Materials.



The inner and outer pre -chambers provide excellent noise and thermal insulation.



REFERENCE

Residential building, REHAU window systems

WINDOWS MADE OF REHAU EURO-DESIGN 60

THE IDEAL SOLUTION WITH BRAND QUALITY



The ideal solution at high standard

Windows made of Euro-Design 60 are visually pleasing in any house with a smooth surface and elegant 15° chamfers. The double seal system keeps out draughts, dust and water ensuring pleasant living comfort.

Euro-Design 60 window solutions are based on a 3-chamber system with a construction depth of 60 mm, enabling them to be both of dependable high quality and cost effective.

Keeping it quiet

If it is noisy outside, your home should be quiet inside. Windows made of Euro-Design 60 achieve this effect. Despite sources of very loud noise in your immediate vicinity. Windows made of Euro-Design 60 can be individually matched to your sound insulation requirements in residential areas that are particularly loud. So relax at home, even if the outside noise is excessive.

3 chambers and a 60 mm construction depth

Traffic volume	Distance from house to centre of street	Recommended noise insulation value* of window	Achievable with Euro-Design 60
Quiet residential street 1500 vehicles/day	30-12 m	28-29 dB	✓
Quiet residential street 1500 vehicles/day	12-5 m	30-34 dB	✓
Main road 30,000 vehicles/day	150-80 m	35-39 dB	✓
Main road 30,000 vehicles/day	80-30 m	40-44 dB	✓

* Noise reduction level of a window



U_f -value of frame-sash combination of $1.7 \text{ W/m}^2\cdot\text{K}$

Attained U_w -value of window of $1.5 \text{ W/m}^2\cdot\text{K}$ of casement window size $1800 \text{ mm (ht)} \times 1500 \text{ mm (wt)}$ with Low-E double-glazed glass ($5+12\text{A}+5 \text{ mm}$)

REFERENCE

Residential building, REHAU window systems



WINDOWS MADE OF REHAU EURO-DESIGN SLIDE

NEW GENERATION 60 MM WINDOW AND DOOR SYSTEMS



The REHAU Euro-Design Slide is a REHAU UPVC extruded profile and other components collectively known as a Window and Door System. The individual profiles and components have been designed in order to be combinable with other REHAU window systems to achieve different varieties of window and door configurations in a variety of styles and sizes. The multi-chamber technique utilizes the insulating effect of air and optimizes the good heat insulation. REHAU Euro-Design Slide has a common construction depth of 60 mm that offers versatility and is ideal in meeting requirements for renovation and new construction applications in residential and commercial buildings. It has an optimized frame to sash overlap of 8 mm that ensures tight clasp improving energy saving and avoiding water and dust penetration.

2-3 chambers and a 60 mm construction width



Effective thermal insulation is being through an ideal construction depth of 70 mm and 5-chamber technology.
 U_f -value: 1.3 W/m²K



REFERENCE

Residential building, REHAU window systems

WINDOWS MADE OF REHAU EURO-DESIGN 70

EFFECTIVE THERMAL INSULATION AND DIVERSITY OF DESIGN
FOR PRESTIGIOUS HOUSING



Attractive design for your home

If you invest a lot in your home and you want it to match your personal tastes down to the finest detail, windows made of Euro-Design 70 make coming home a pleasant occasion. This is particularly so if you have special design requirements, as windows made of Euro-Design 70 complement the appearance of your home perfectly. With different window shapes and sash designs (recessed or rounded), you have many options to choose from.

Keeping it quiet

Windows made of Euro-Design 70 ensure peace and quiet inside even when it is very noisy outside. They can be individually matched to your noise insulation requirements for residential areas that are particularly loud. So relax at home, even if the outside noise is excessive. Euro-Design 70 – excellent sound insulation for all requirements.

Attractive and easy to clean: The profiles have an unrivalled, high-quality surface and a particularly precious appearance.

Traffic volume	Distance from house to centre of street	Recommended noise insulation value* of window	Achievable with Euro-Design 70
Quiet residential street 1500 vehicles/day	30-12 m	28-29 dB	✓
Quiet residential street 1500 vehicles/day	12-5 m	30-34 dB	✓
Main road 30,000 vehicles/day	150-80 m	35-39 dB	✓
Main road 30,000 vehicles/day	80-30 m	40-44 dB	✓

* Noise reduction level of a window

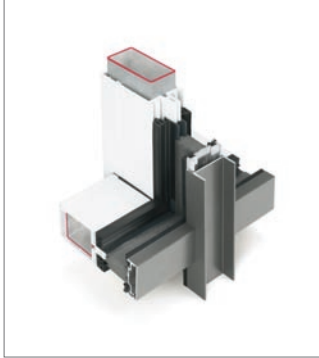

REFERENCE

Technology Park, curtain walling system

CURTING WALLING REHAU-POLYTEC 50 S

EFFECTIVE THERMAL INSULATION AND DIVERSITY OF DESIGN FOR PRESTIGIOUS HOUSING



REHAU-Polytec 50 S is an economical and architecturally sophisticated facade solution with high energy efficiency. For customized design a multitude of aluminium cover profiles with a profile view of 50 mm is available. REHAU-Polytec 50 S can be combined with all REHAU window profile systems.

Benefits:

- High insulation facade designs for energy-efficient building- Single- and multi-storey curtain wall (e.g. facade band, staircase)
- Large-area glazing (display windows) possible- Pitched facades (e.g. angular facade)
- Integration of appropriate REHAU window systems into the façade
- Integration of innovative technologies (e.g. solar cells) in the facade
- Creative freedom by profile and colour variety
- Security through a tested system
- Different PVC shrouds (building interior) to static or architectural requirements
- Uniform slim sightline

Thermal Performance Testing



System Test Report



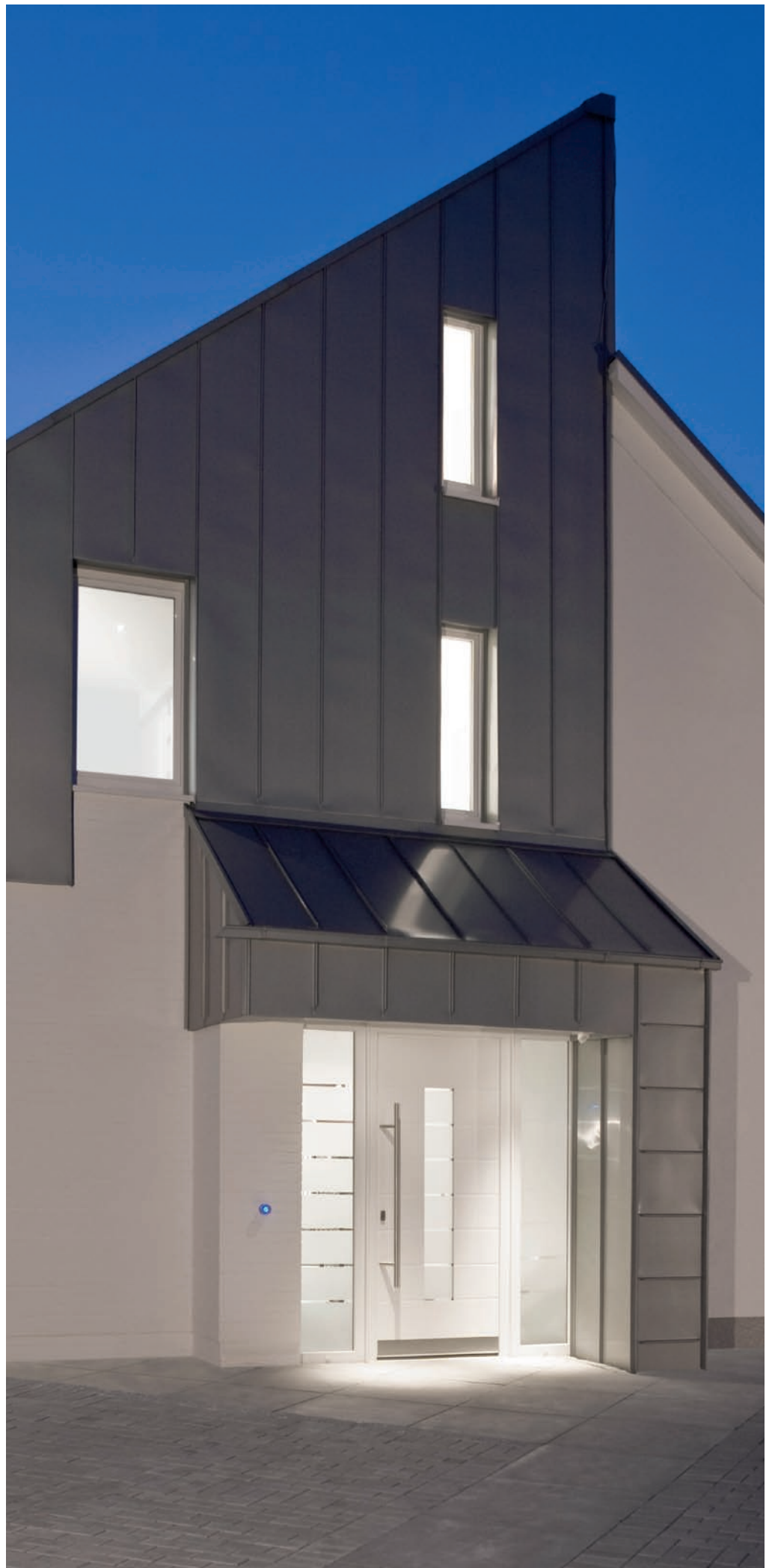

REFERENCE

Residential building, REHAU window systems

ENERGY EFFICIENCY IN PERFECTION

ONLY THE BEST FOR THE FUTURE – THE NEW GENE[®] WINDOW SYSTEM
MADE FROM HIGH-TECH MATERIAL RAU-FIPRO[®]



This quality-mark assures highest energy savings

REHAU's window, door and curtain walling systems bring high quality and ground breaking technology to its products which can meet the requirements for both commercial and domestic applications. Our latest GENE window system is manufactured using the high-tech RAU-FIPRO material resulting in windows with a reduction in energy losses of up to 76%*.

1. Highest quality

The best initial materials combined with the highest processing benchmarks result in the outstanding quality and long service life of profiles made from RAU-FIPRO. And this under even the highest stress levels.

2. Uniquely innovative

With a high-tech fiber composite material, this branch-specific novelty sets an example. After aircraft construction and formula 1 design, fiber composite materials now also offer the best performance in the area of window design.

3. Unbeatably stable

RAU-FIPRO – represents high-tech in combination with an innovative material formulation. The highest level of profile core stability sets new benchmarks for window profile systems.



Certification of highest quality



* Reduction in the energy loss from windows when replacing old wooden/plastic windows from the 80s ($U_f = 1.9$, $U_g = 3.0$) with windows made from GENE profiles ($U_f = 0.91$, $U_g = 0.5$, window size 123 x 148 cm).

EFFECTIVE SOUND INSULATION

INGENIOUS DESIGN KEEPING NOISE LOW

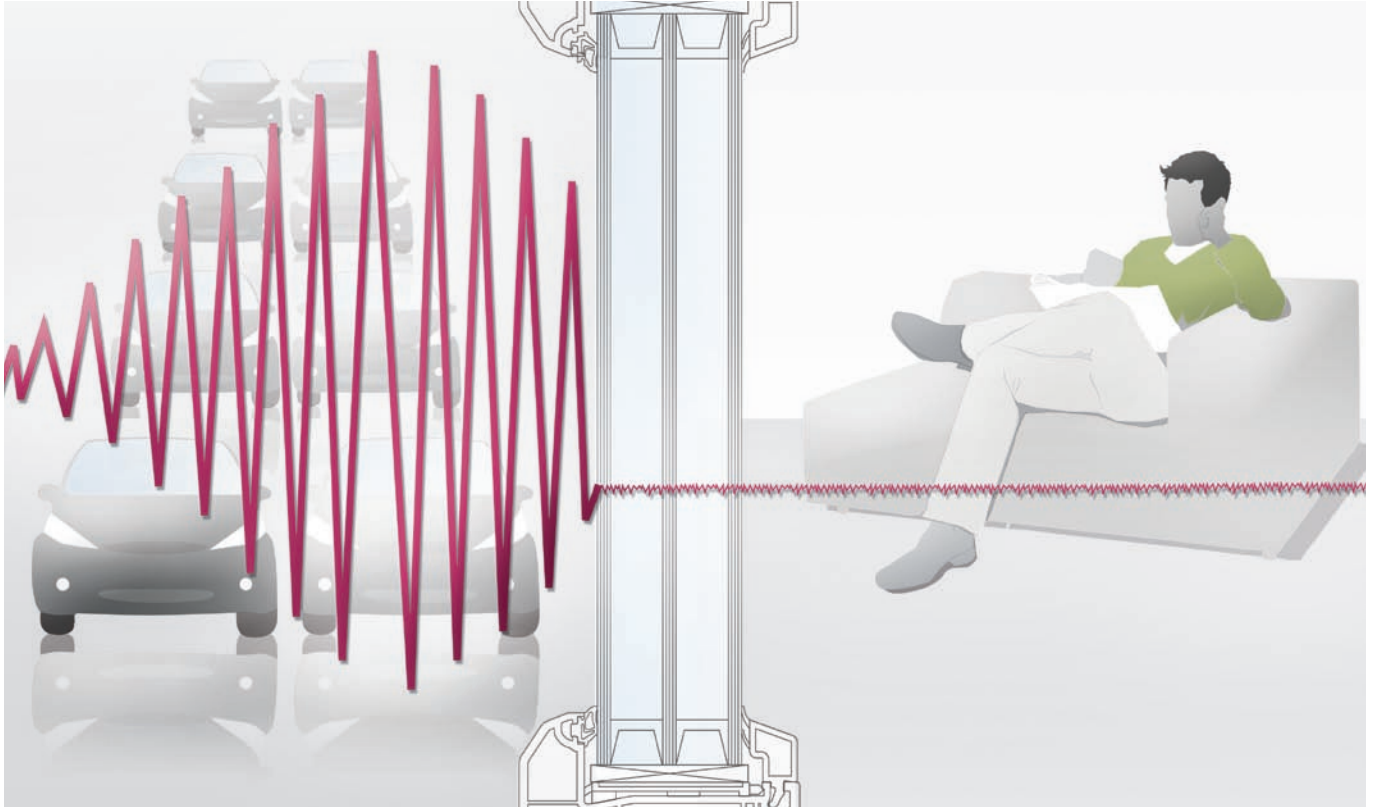

To concentrate at work or relax after a hard day, the one factor needed for optimum results is a peaceful and quiet environment.

Tailor-made noise protection system so nothing can disturb your peaceful world

Certification of highest sound isolation



REHAU window systems are perfectly designed to reduce sound transmission. The compression gaskets assure the tightness of the windows and doors.

Combined with suitable glazing and installed in a professional way REHAU windows can achieve a sound reduction of up to 47dB. This easily exceeds the recommended sound – proofing level for bedrooms even in busy town centers.

EFFECTIVE DUST PROOFING

INGENIOUS DESIGN KEEPING YOUR HOME CLEAN



Especially in regions with extreme climatic conditions, the air is often filled with dust and sand. Therefore windows with a high level of air and water tightness are crucial to comfortable living.

Due to the high technical standard, windows made of REHAU profile systems are extremely weather resistant and offer tightness against dust and rain for a cozy living.

Dust Proofing

The sealing in REHAU Window Systems is calibrated to achieve excellent air tightness of less than $0.1 \text{ m}^3/\text{hr}/\text{m}^2$ at 10 Pa (tested in accordance with GB/T7107-2002). This effectively stops dust drifting in from the outside, which drastically reduces the time you'll need for cleaning your home

Euro-Design Slide

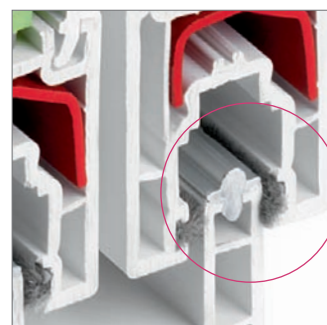

Euro-Design 60

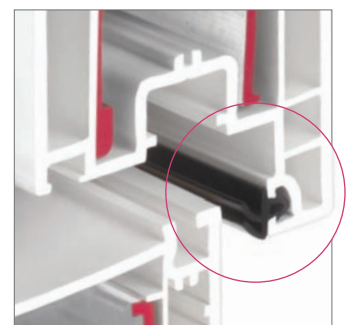

Circular seals keep out draughts, sand and wind

INNOVATIVE SYSTEMS FOR CONSTRUCTION

FROM ENERGY-EFFICIENT CONSTRUCTION TO RESOURCE-PRESERVING WATER MANAGEMENT

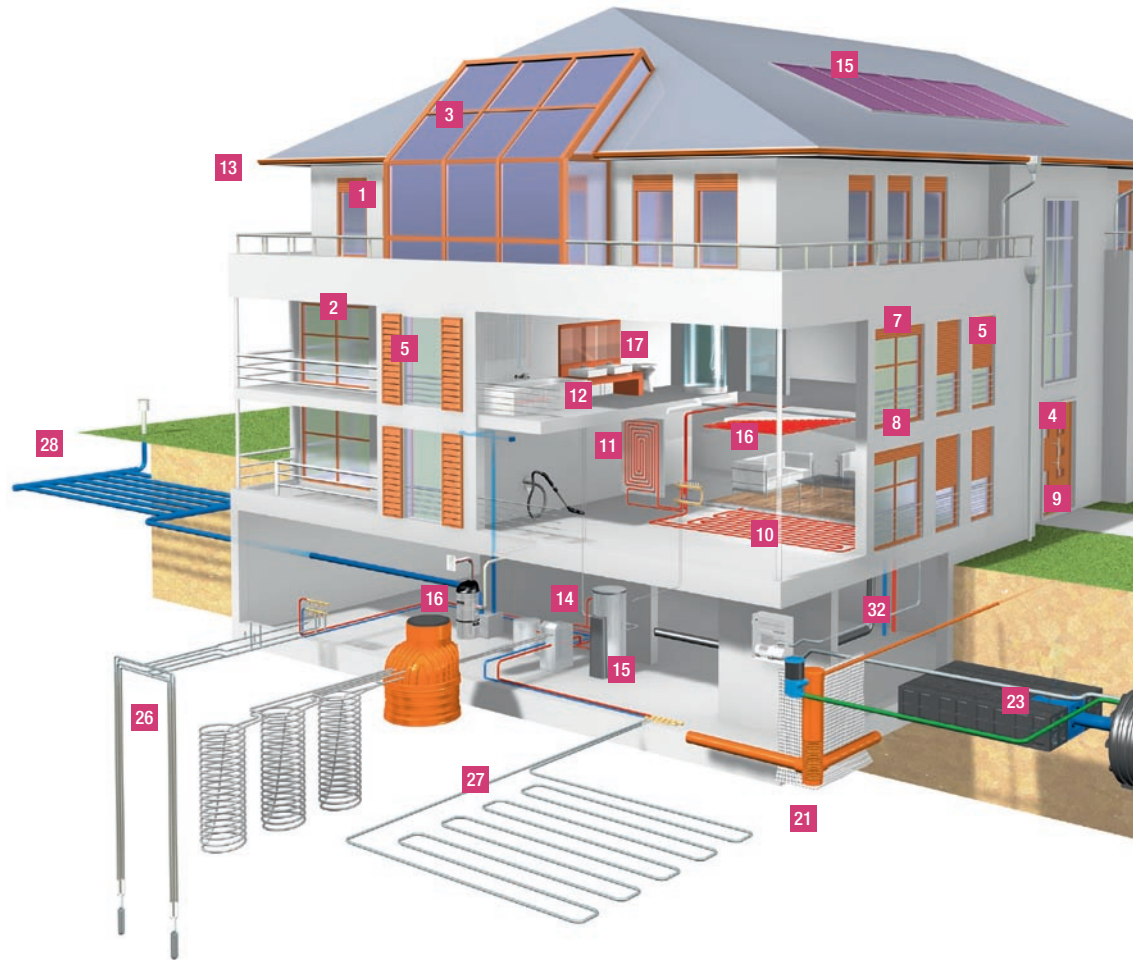

Window and curtain walling technology

Systems for:

- 1** Windows
- 2** French windows
- 3** Curtain walling
- 4** Residential doors
- 5** Roller shutters and folding shutters
- 6** Conservatories
- 7** Ventilation technology
- 8** Interior window boards
- 9** Infill panels for residential doors
- 10** Lift-slide patio doors
- 11** Passive house certified solutions

Building technology

Systems for:

- 12** Underfloor heating/cooling
- 13** Wall heating/cooling
- 14** Drinking water and heating installations
- 15** Roof drainage
- 16** Heat pumps
- 17** Solar thermal energy
- 18** Central vacuum cleaner systems
- 19** Sound insulating domestic waste water systems
- 20** Outdoor facility heating
- 21** Concrete core tempering
- 22** Gas installations
- 23** Electrical installations



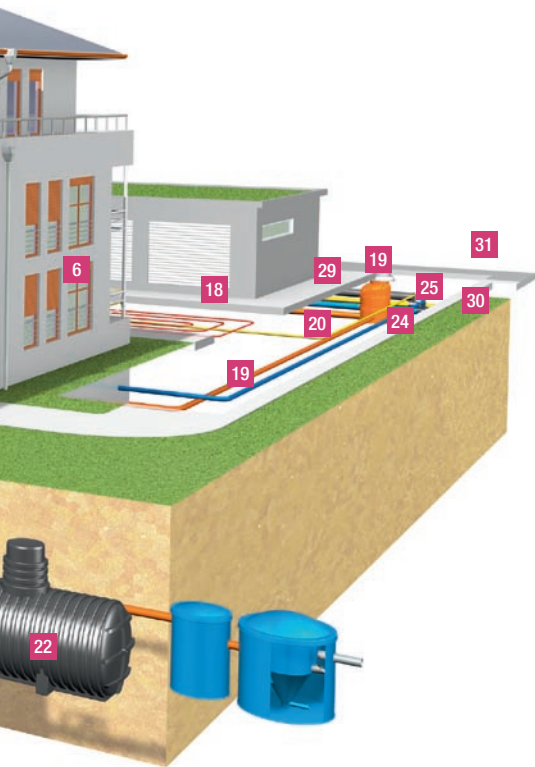

Window and Curtain Walling Technology

REHAU offers profile systems for windows, exterior doors, roller shutters, folding shutters, conservatories and curtain walling. Whether the job entails renovation or new construction, REHAU stands for systems solutions and outstanding service throughout every construction phase from project planning to final realization.

Building Technology

REHAU offers systems solutions for underfloor heating/cooling, plumbing, heating and gas installations, cable management, solar thermal energy, industrial pipelines and compressed air networks.

Civil Engineering

REHAU offers system solutions for water supply and distribution, communications technology, geothermal energy technology, rainwater management, road construction, underground and foundation construction, and waste disposal.

Civil Engineering & Infrastructure

Systems for:

- 19** Waste water and rainwater sewer systems
- 20** Sewage shafts
- 21** Civil engineering pipes and drainage
- 22** Rainwater utilisation
- 23** Rainwater seepage
- 24** Drinking water pipelines
- 25** Gas pipelines
- 26** Geothermal heat recovery with probes
- 27** Geothermal heat recovery with collectors
- 28** Ground-air heat exchangers
- 29** Communications lines
- 30** Trenchless technology for installation of cables and pipelines
- 31** Earthworks and traffic route construction
- 32** Building inlets
- Local and district heating/cooling supply



OUR STRENGTH – YOUR ASSURANCE

THESE ADVANTAGES ARE CONVINCING



PROXIMITY TO THE CUSTOMER BY SERVICE ON SITE

REHAU ACADEMY

Knowledge assures success:

Risk minimization through excellent

- Technical information
- Software for planning and planning support on request
- On-site instruction
- The well-known, proven REHAU quality

REHAU e-services:

- Customer portal
- Tender texts and documents to download: quick and easy
- 24 h service, seven days per week

Newsletter

Up-to-date with the newsletter „REHAU News and Innovations, Construction“



Support of window fabricators.

REHAU offers comprehensive advice and assistance for the establishment and management of a modern window fabrication plant.



Window calculating software – Fast and precise planning

The REHAU window software provides you with professional support for all your planning, development and tendering needs. Be amazed by the capabilities of our software.

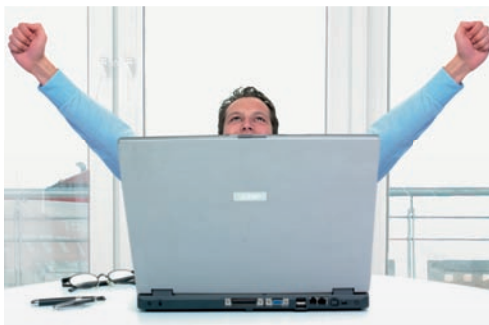

Authorized REHAU partner – German quality standards

All our window fabricators work on the highest German quality level. Therefore the Authorized REHAU partners are trained regularly by our German engineers.



ALL FROM A SINGLE SOURCE

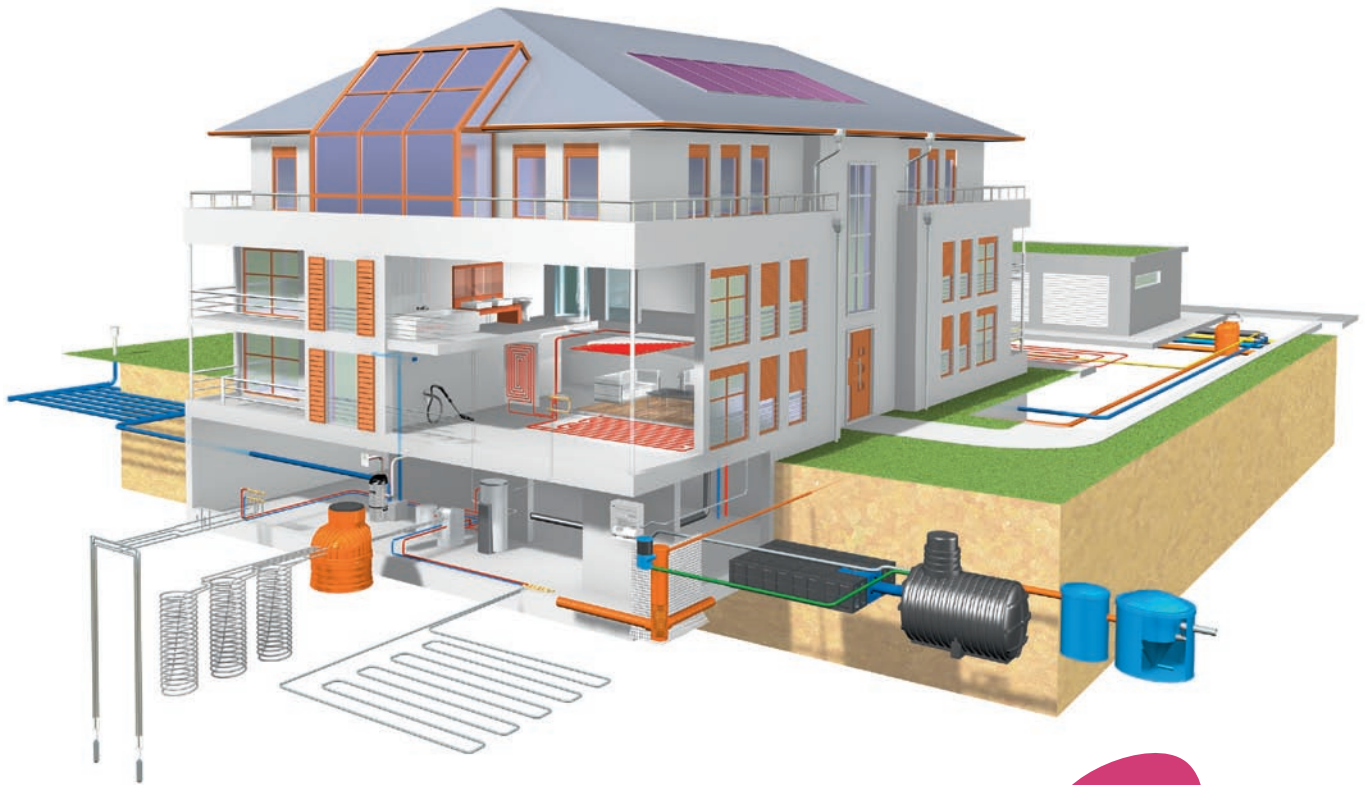

As a leading supplier of system solutions to the construction industry, REHAU also faces up to the challenges of ecology and economy, design and functionality, safety and convenience in building. You too can benefit from the REHAU systems.

REHAU SALES OFFICE:
UAE: Dubai, Phone: +971488 35677, dubai@rehau.com

